

Full-Motion TV Mount - 23" to 42"

Installation Guide



Full-motion/articulating universal LCD/Plasma TV wall-mount
TV size: 23" - 42"
Tilt angle: 0 - 12 degrees
Max load capacity: 100 lbs
Wall distance: 3.75" to 21.25"
Bubble level included
Universal Mounting Pattern

Important: If you have difficulty following or understanding these installation instructions, please consult a qualified installation specialist.



Caution

- Prior to installation of this product, the installation guide should be read and completely understood. The installation guide must be read to prevent personal injury and property damage. Keep the installation guide in an easily accessible location for future reference.
- This mount contains small parts which can act as a choking hazard if swallowed.
- CAUTION: The maximum load capacity is 100 lbs. Use with products exceeding the maximum load capacity may cause serious injury. See apparatus instructions.
- The wall structure must be capable of supporting at least five (5) times the maximum load capacity as indicated. If not, the wall must be reinforced.
- Recommended mounting surfaces: wood stud and solid-flat concrete. If the mount is to be installed on any surface other than wood studs or solid concrete, use suitable hardware (not included but commercially available).
- Do not install on a structure that is prone to vibration, movement or chance of impact. Failure to do so could result in damage to the display and/or damage to the mounting surface.
- Do not install near heater, fireplace, air conditioning, in direct sunlight or any other heat producing source. Failure to do so may result in damage to the display and could increase the risk of fire.
- Make sure no water or natural gas lines are present where the mount is to be installed. Cutting or drilling into water or natural gas lines could cause personal injury or property damage.
- Proper installation procedure by yourself or a qualified service technician, as outlined in the installation guide, must be adhered to. Failure to do so could result in serious personal injury.
- When mounting to a wall that contains wood studs, confirm the dead center of the wood stud prior to installation, it is recommended that the wood studs be a minimum of 16" apart (if applicable).
- This product is intended for indoor installation/use only. Premature product failure or serious personal injury could occur if this product is used outdoors.
- It is recommended that two people perform the installation. Injury and/or damage can result from dropping or mishandling the display.

Hardware Kit

A



(x4) M4x12
screw

B

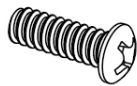

(x4) M5x16
screw

C

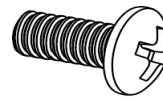

(x4) M6x16
screw

D

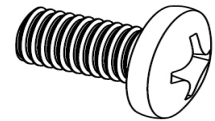

(x4) M8x16
screw

E



(x4) M4x30
screw

F

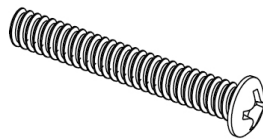

(x4) M5x35
screw

G

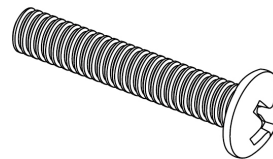

(x4) M6x35
screw

H

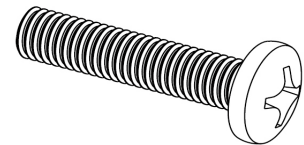

(x4) M8x35
screw

I

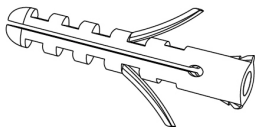

(x6) Concrete
anchor

J

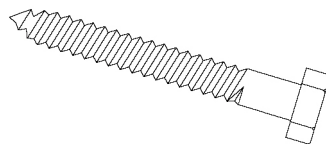

(x6) Bolt

K

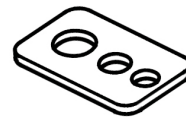

(x4) M8/M6/M5
rectangular washer

L-1

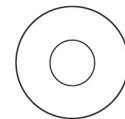

(x6) M8 washer

L-2

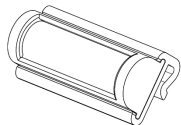

(x1) Bubble level

M

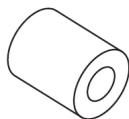

(x4) Spacer

M

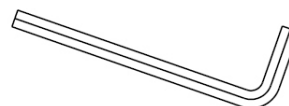

(x1) Wrench

Important: The Full-Motion TV Mount - 23" to 42" is shipped with the proper installation hardware and parts. Make sure that none of the items are missing or damaged before starting the installation. If there are any missing and/or damaged parts, please stop the installation and contact your place of purchase.

Tools Required

- Electronic stud finder for drywall installation
- Phillips head screw driver
- 5/16" socket and wrench
- Electric drill, 3/16" drill bit for wood stud installation, 1/2" masonry drill bit for concrete/brick wall installation

IMPORTANT: Please ensure that the bubble level (L-2) is properly mounted to the wall plate prior to mounting the wall plate.

Step 1: Wall Plate Installation

A) Wood Stud Installation

1. Use a high quality electronic stud finder (commercially available) to locate dead center of a wood stud and mark the location with a pencil (Figure 1).
2. Attach the bubble level (L-2) to the wall plate and with the help of an assistant ensure the wall plate is level, position the wall plate against the wall in the desired mounting location (Figure 2).
3. Mark the right (upper and lower) and the left (upper and lower) positions of the small horizontal slots that are in alignment with the wood studs.
4. You should mark four positions total. Take down the wall plate.
5. Next, pre-drill a 3/16" hole to a depth of 2" in the wood stud at each marked location.
6. Place the wall plate against the wall and line up the mounting slots with the drilled holes. Check the bubble level to verify that the wall plate is level.
7. For each location, insert a bolt (J) and washer (L-1) into the wall (Figure 3).
8. Tighten the bolt with an open ended socket wrench by turning clockwise until tight (Figure 3).

CAUTION: Do not over tighten the bolts - doing so may cause unnecessary damage to the wall.

CAUTION: Do not release the wall plate until it is properly mounted and secured to the wall.

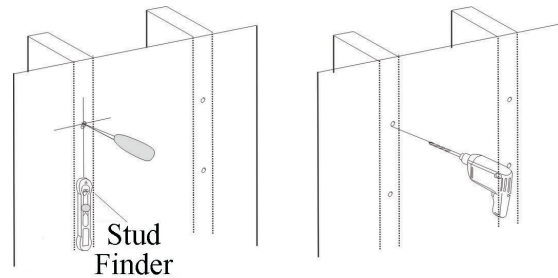

Figure 1

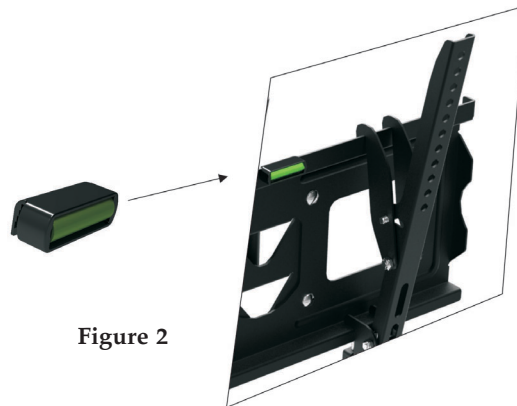

Figure 2

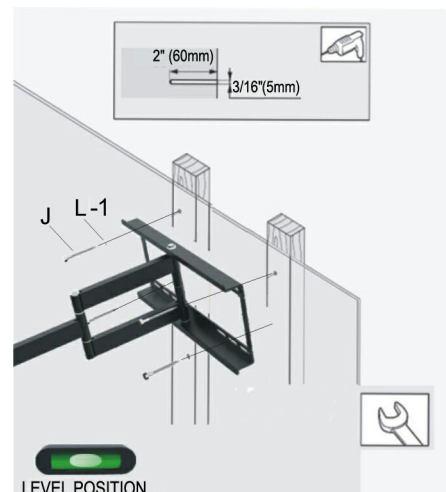

Figure 3

B) Concrete / Brick Wall Installation

Note: The concrete anchors must be used for concrete and brick installation.

1. Attach the bubble level (L-2) to the wall plate, with the help of an assistant place the wall plate into position against the wall, using the bubble level to keep it level.
2. Mark six holes to be used for securing the mount, and place the wall plate aside. Locate the holes directly into the concrete or brick, never into the mortar between the blocks (Figure 4).
3. Drill six holes using an electric drill and 1/2" masonry drill bit to a depth of 2" at the positions you marked.
4. Insert a concrete anchor (I) into each hole.
5. If necessary, a hammer can be used to lightly tap each concrete anchor into place so that they are flush with the wall.
6. Once all of the concrete anchors are in place, move the wall plate back into position. Check the bubble level to verify that the wall plate is level.
7. Insert bolts (J) and washers (L-1) into the concrete anchors as shown (Figure 4) and tighten. Do not fully tighten until all bolts are in place.

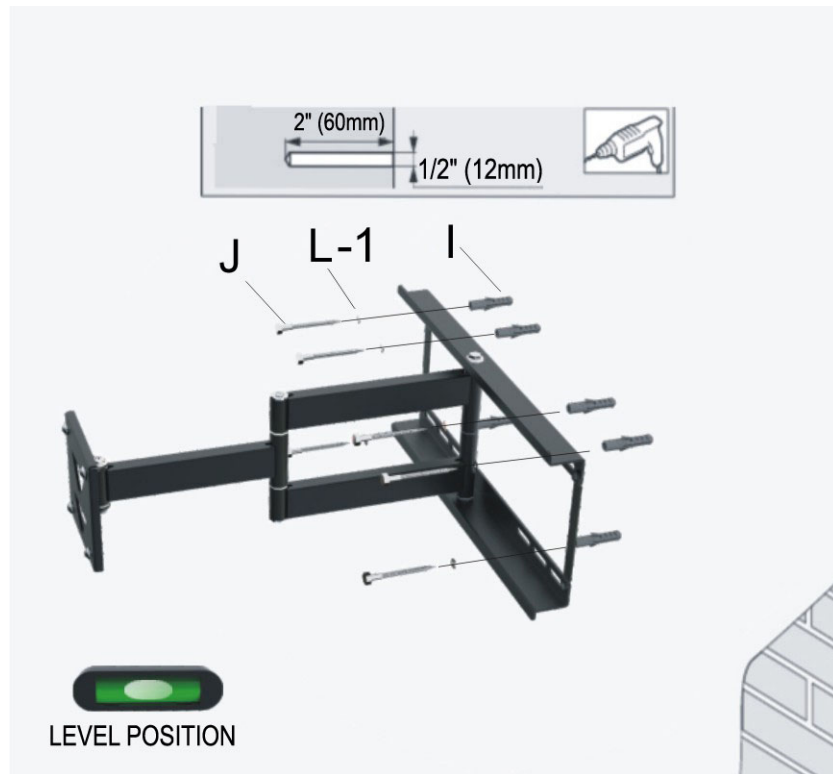

Figure 4

CAUTION: Do not over tighten the bolts - doing so may cause unnecessary damage to the wall.

CAUTION: Do not release the wall plate until it is properly mounted and secured to the wall.

Step 2: Display Plate Installation

The hardware kit includes screws of various diameters and lengths to ensure optimal installation.

1. Place your TV screen down on a soft, flat surface, and locate the threaded mounting points that are located on the back of the display (Figure 5).
2. Determine which screw (A/B/C/D/E/F/G/H) is of the correct length by carefully inserting a straw or toothpick, and mark how deep the mounting point is (Figure 6 and Figure 6-1).
3. If your display has a curved back or recessed thread mounting point, a spacer (M) must be used. Place the spacer (M) between the mounting bracket and display (Figure 6-1).
4. According to the size of the display's hole, choose the corresponding screw (A/B/C/D/E/F/G/H) and hole on the rectangular washer (I), then thread them in line (Figure 6 and Figure 6-1).



Figure 5

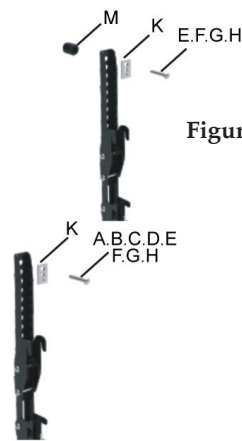

Figure 6-1

Figure 6

Step 3: Final Installation and Adjustment

1. Hang the display plate onto the top of the wall plate and slip it into the wall plate as shown (Figure 7).
2. Tilt the display to the desired angle (Figure 8).

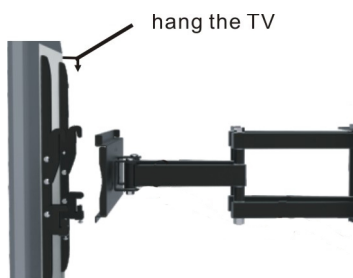

Figure 7

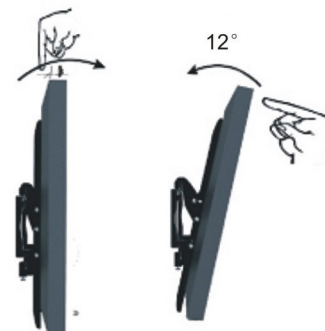

Figure 8

3. Tighten the bottom screw to lock the bracket (Figure 9).
4. Tighten the top two screws to secure the tilt angle (Figure 10).

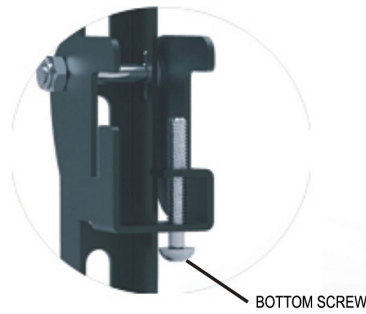

Figure 9

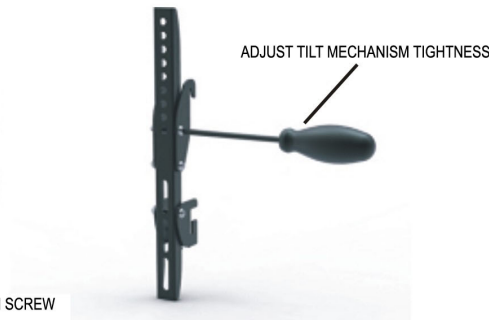

Figure 10

5. Secure the cables from your LCD TV / Monitor through the cable management loops (Figure 11).



Figure 11

Swivel Adjustment

If the swivel joints are too loose or too tight, they can be adjusted using the wrench (M) provided in the hardware kit (Figure 12).



Figure 12

Maintenance

Check the mounting screws every two months for tightness.

Technical Support and Warranty

QUESTIONS? SIIG's **Online Support** has answers! Simply visit our web site at www.siig.com and click **Support**. Our online support database is updated daily with new drivers and solutions. Answers to your questions could be just a few clicks away. You can also submit questions online and a technical support analysts will promptly respond.

SIIG offers a 5-year manufacturer warranty with this product. This warranty covers the original purchaser and guarantees the product to be free of any defects in materials or workmanship for five (5) years from the date of purchase of the product.

SIIG will, at our discretion, repair or replace (with an identical product or product having similar features and functionality) the product if defective in materials or workmanship. This warranty gives you specific legal rights, and you may also have other rights which vary from state to state. Please see our web site for more warranty details.

If you encounter any problems with this product, please follow the procedures below.

- A) If it is within the store's return policy period, please return the product to the store where you purchased it.
B) If your purchase has passed the store's return policy period, please follow these steps to have the product repaired or replaced.

Step 1: Submit your RMA request. Go to www.siig.com, click **Support**, then **Request A Product Replacement** to submit a request to [SIIG RMA](#) or fax a request to 510-657-5962. Your RMA request will be processed, if the product is determined to be defective, an RMA number will be issued.

Step 2: After obtaining an RMA number, ship the product.

- Properly pack the product for shipping. All software, cable(s) and any other accessories that came with the original package must be included.
- Clearly write your RMA number on the top of the returned package. SIIG will refuse to accept any shipping package, and will not be responsible for a product returned without an RMA number posted on the outside of the shipping carton.
- You are responsible for the cost of shipping to SIIG. Ship the product to the following address:

SIIG, Inc.
6078 Stewart Avenue
Fremont, CA 94538-3152, USA
RMA #: _____

- SIIG will ship the repaired or replaced product via Ground in the U.S. and International Economy outside of the U.S. at no cost to the customer.

About SIIG, Inc.

Founded in 1985, SIIG, Inc. is a leading manufacturer of IT connectivity solutions (including Serial ATA and Ultra ATA Controllers, FireWire, USB, and legacy I/O adapters) that bridge the connection between Desktop/Notebook systems and external peripherals. SIIG continues to grow by adding A/V and Digital Signage connectivity solutions to our extensive portfolio. All centered around the distribution and switching of A/V signals over CAT5/6, these products include matrix switches, distribution amplifiers, extenders, converters, splitters, cabling, and more.

SIIG is the premier one-stop source of upgrades and is committed to providing high quality products while keeping economical and competitive prices. High-quality control standards are evident by one of the lowest defective return rates in the industry. Our products offer comprehensive user manuals, user-friendly features, and most products are backed by a lifetime warranty.

SIIG products can be found in many computer retail stores, mail order catalogs, and e-commerce sites in the Americas, as well as through major distributors, system integrators, and VARs.

PRODUCT NAME

Full-Motion TV Mount - 23" to 42"

FCC RULES: TESTED TO COMPLY WITH FCC PART 15, CLASS B OPERATING ENVIRONMENT: FOR HOME OR OFFICE USE

FCC COMPLIANCE STATEMENT:

This device complies with part 15 of the FCC Rules. Operation is subject to the following two conditions: (1) This device may not cause harmful interference, and (2) this device must accept any interference received, including interference that may cause undesired operation.

THE PARTY RESPONSIBLE FOR PRODUCT COMPLIANCE

SIIG, Inc.
6078 Stewart Avenue
Fremont, CA 94538-3152, USA
Phone: 510-657-8688

Full-Motion TV Mount - 23" to 42" is a trademark of SIIG, Inc. SIIG and the SIIG logo are registered trademarks of SIIG, Inc. All other names used in this publication are for identification only and may be trademarks of their respective owners.

November, 2013

Copyright © 2013 by SIIG, Inc. All rights reserved.