

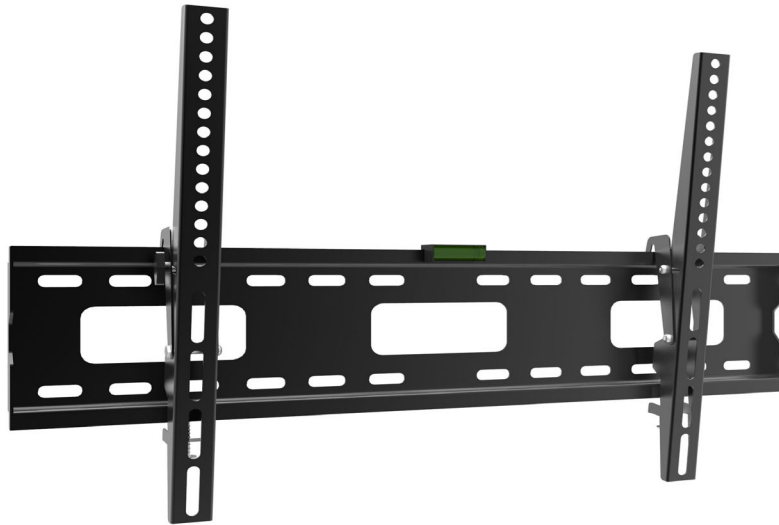

Low Profile Universal Tilted TV Mount - 32" to 65" Installation Instructions



Tilting Flat Screen TV Wall Mount

Material: Cold Rolled Steel Plate

TV size: 32" - 65"

Max load capacity: 110 lbs / 50 kgs

Wall distance: 1.8" / 45 mm

Important: If you have difficulty following or understanding these installation instructions, please consult a qualified installation specialist.



Caution

- Prior to installation of this product, the installation instructions should be read and completely understood. The installation instructions must be read to prevent personal injury and property damage. Keep these installation instructions in an easily accessible location for future reference.
- This mount contains small parts which can act as a choking hazard if swallowed.
- **CAUTION:** The maximum load capacity is 110 lbs. Use with products exceeding the maximum load capacity may cause serious injury. See apparatus instructions.
- The wall structure must be capable of supporting at least five (5) times the maximum load capacity as indicated. If not, the wall must be reinforced.
- Recommended mounting surfaces: wood stud and solid-flat concrete/brick. If the mount is to be installed on any surface other than wood studs, solid concrete or brick, use suitable hardware (not included but commercially available).
- Do not install on a structure that is prone to vibration, movement or chance of impact. Failure to do so could result in damage to the display and/or damage to the mounting surface.
- Do not install near heater, fireplace, air conditioning, in direct sunlight or any other heat producing source. Failure to do so may result in damage to the display and could increase the risk of fire.
- Make sure no water or natural gas lines are present where the mount is to be installed. Cutting or drilling into water or natural gas lines could cause personal injury or property damage.
- When mounting to wood studs, it is recommended that a maximum 5/8" particle board be used.
- When mounting to a wall that contains wood studs, confirm the dead center of the wood stud prior to installation, it is recommended that the wood studs be a minimum of 16" apart (if applicable).
- Proper installation procedure by yourself or a qualified service technician, as outlined in the installation instructions, must be adhered to. Failure to do so could result in serious personal injury.
- This product is intended for indoor installation/use only. Premature product failure or serious personal injury could occur if this product is used outdoors.
- It is recommended that two people perform the installation. Injury and/or damage can result from dropping or mishandling the display.
- If you don't understand these installation instructions, please consult an installation specialist.

Hardware Kit

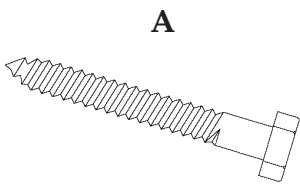

(x4) Bolt

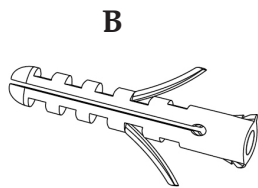

(x4) Plastic anchor

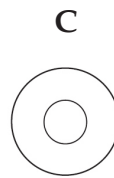

(x4) Washer

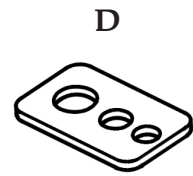

(x4) Rectangular washer

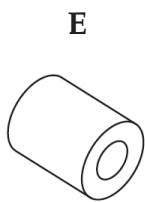

(x4) Spacer

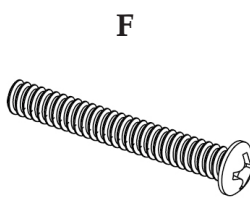

(x4) M5x30 screw

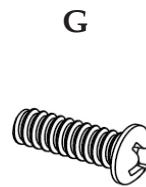

(x4) M5x15 screw

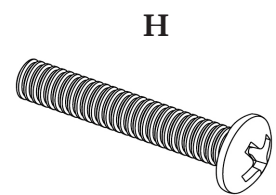

(x4) M6x30 screw

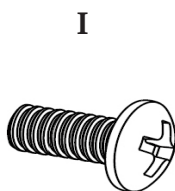

(x4) M6x15 screw

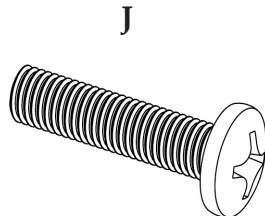

(x4) M8x30 screw

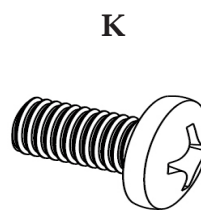

(x4) M8x15 screw

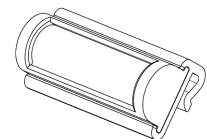

(x1) Bubble level

Important: The Low Profile Universal Tilted TV Mount - 32" to 65" is shipped with the proper installation hardware and parts. Make sure that none of the items are missing or damaged before starting the installation. If there are any missing and/or damaged parts, please stop the installation and contact your place of purchase.

Tools Required

- Electronic stud finder for wood stud installation
- Phillips head screw driver
- Socket and/or wrench set
- Electric drill, 3/16" (5mm) drill bit for wood stud installation, 3/8" (10mm) masonry drill bit for concrete/brick wall installation

Step 1: Wall Plate Installation

A) Wood Stud Installation

NOTE: For secure wood stud mounting, the wall plate must be mounted to two studs at least 16" apart.

1. Use a high quality electronic stud finder (commercially available) to locate dead center of two adjacent wood studs and mark the location with an awl or pencil (figure 1-a).
2. Attach the Bubble Level to the wall plate and with the help of an assistant ensure the wall plate is level, position the wall plate against the wall in the desired mounting location (figure 1-b).
3. Mark the right (upper and lower) and the left (upper and lower) positions of the small horizontal slots that are in alignment with the wood studs.
4. You should mark four positions total. Take down the wall plate.
5. Next, pre-drill a 3/16" hole to a depth of 3" in the wood stud at each marked location (figure 1-c).
6. Position the wall plate against the wall and line up the mounting slots with the drilled holes. Check the bubble level to verify that the wall plate is level.
7. For each location, insert Bolt (A) and Washer (C) into the wall (figure 1-d).
8. Tighten each bolt with an open ended wrench or socket wrench by turning clockwise until tight. Do not fully tighten until all bolts are in place.

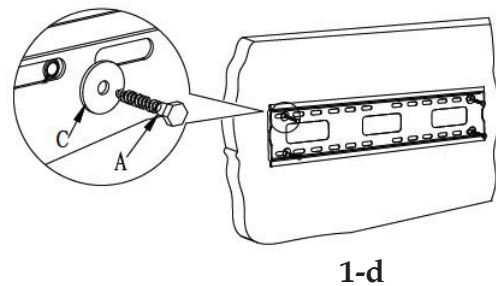
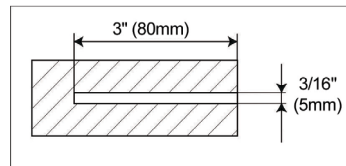
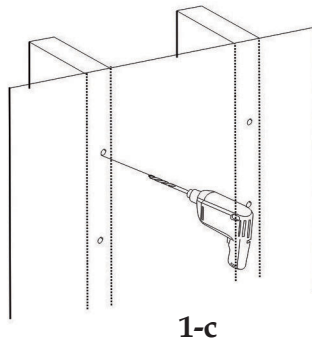
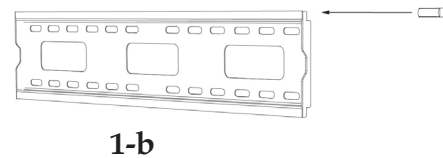
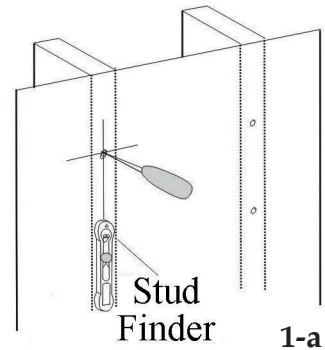

CAUTION: Do not over tighten the bolts - doing so may cause unnecessary damage to the wall. Avoid excessive torque.

CAUTION: Do not release the wall plate until it is properly mounted and secured to the wall.

B) Concrete / Brick Wall Installation

Note: The Plastic Anchors must be used for concrete and brick wall installation.

1. Attach the Bubble Level to the wall plate, with the help of an assistant place the wall plate into position against the wall, using the bubble level to ensure it is level (figure 1-e).
2. Mark four holes to be used for securing the mount, and place the wall plate aside. Locate the holes directly into the concrete or brick, never into the mortar between the blocks.
3. Drill holes using an electric drill and 3/8" masonry drill bit to a depth of 2" at the positions you marked.
4. Insert a Plastic Anchor (B) into each hole (figure 1-f).
5. If necessary, a hammer can be used to lightly tap each Plastic Anchor into place so that they are flush with the wall.
6. Once all of the Plastic Anchors are in place, move the wall plate back into position. Check the bubble level to verify that the wall plate is level.
7. Insert Bolt (A) and Washer (C) into each Plastic Anchor (B) and tighten each bolt with an open ended wrench or socket wrench by turning clockwise. Do not fully tighten until all bolts are in place (figure 1-g).

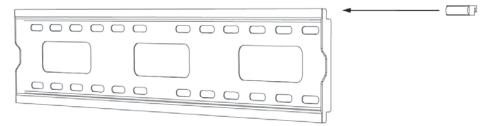

1-e

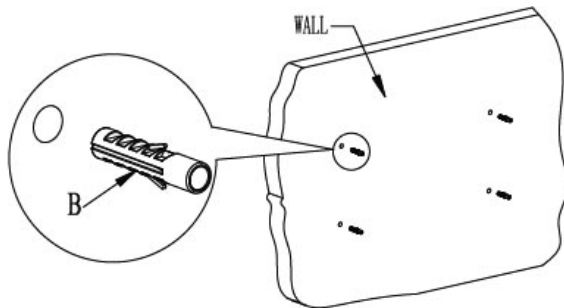

1-f

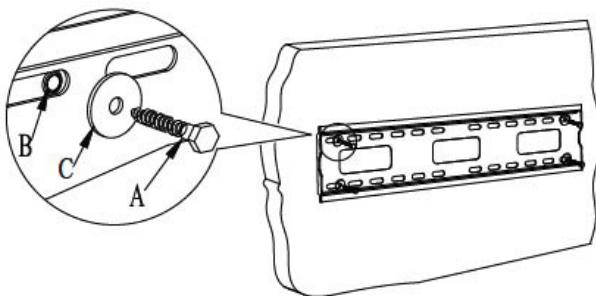
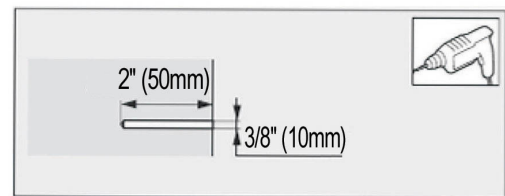

1-g

CAUTION: Do not over tighten the bolts - doing so may cause unnecessary damage to the wall. Avoid excessive torque.

CAUTION: Do not release the wall plate until it is properly mounted and secured to the wall.

Step 2: Display Bracket Installation

The installation kit includes screws of various diameters and lengths to ensure optimal installation.

1. Place your TV screen down on a soft, flat surface, and locate the threaded mounting points that are located on the back of the display.
2. Determine which screw (F/G/H/I/J/K) is of the correct length by carefully inserting a straw or toothpick, and mark how deep the mounting point is.
3. According to the size of the display's hole, choose the corresponding screw and hole on the Rectangular Washer (D), then thread them in line (figure 2-a).
4. If your display has a curved back or recessed thread mounting point, place Spacer (E) between the display bracket and display and then choose screw (F/G/H/I/J/K) to match (figure 2-b).

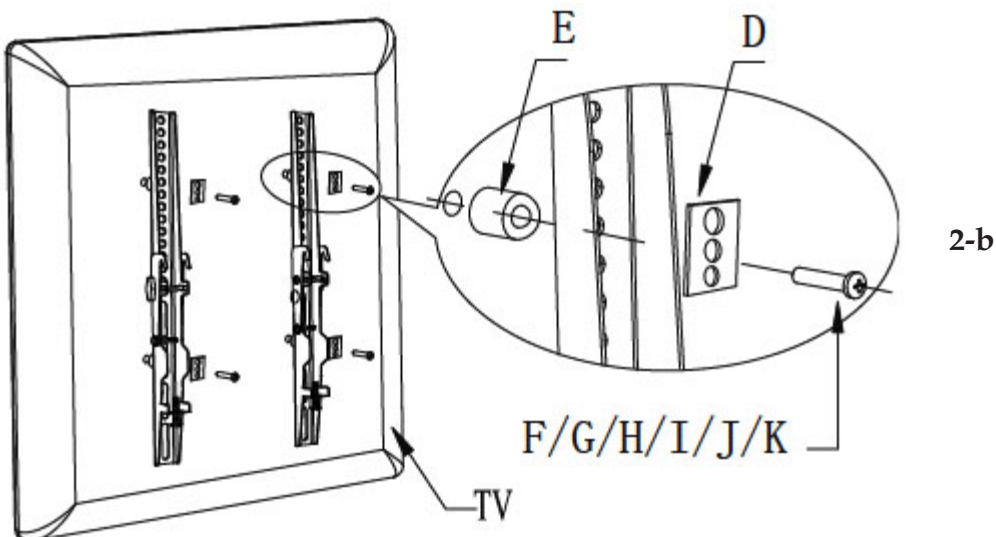
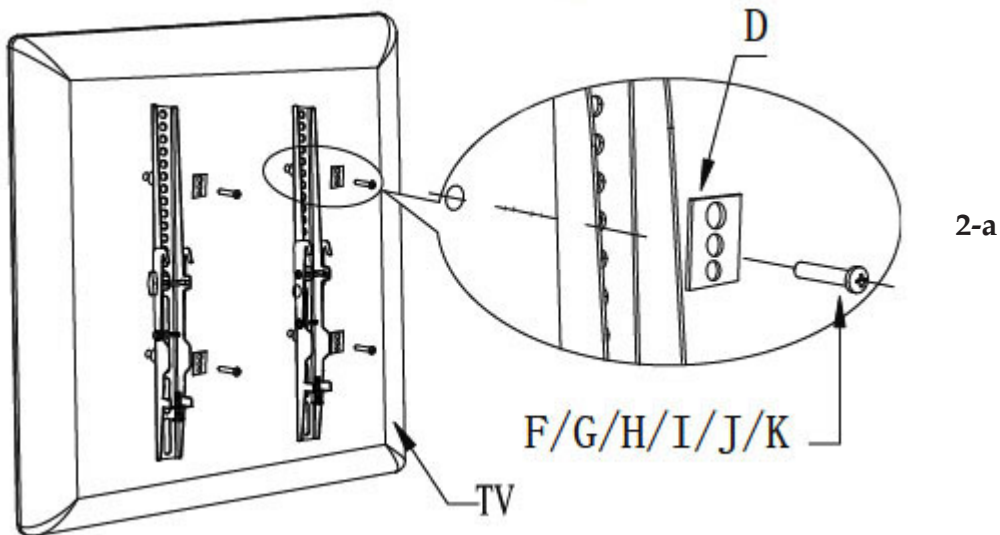

Step 3: Final Installation and Adjustment

1. Hook the display bracket over the top of the wall plate, rotate the bolt at the bottom of the display brackets to tighten and secure the TV to the wall plate (figure 3-a).
2. Tilt the TV to the desired viewing angle, then turn the tilt knobs to secure the position (figure 3-b).

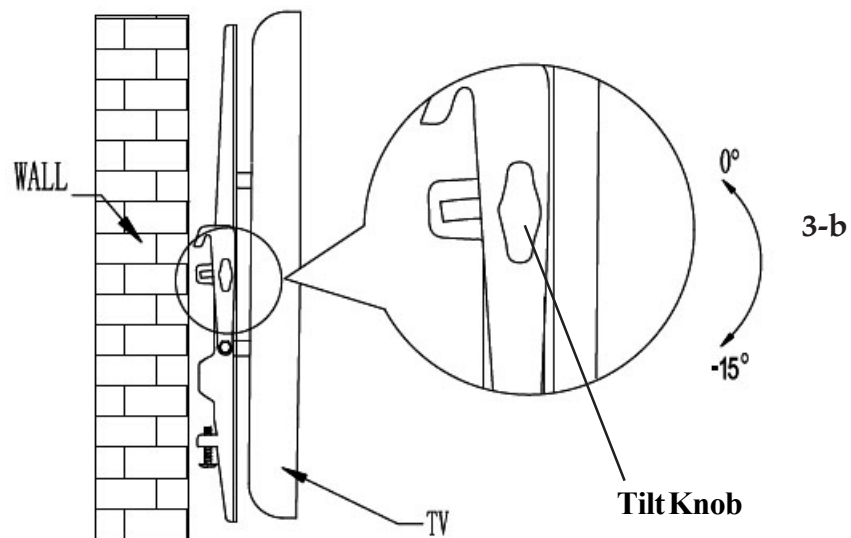
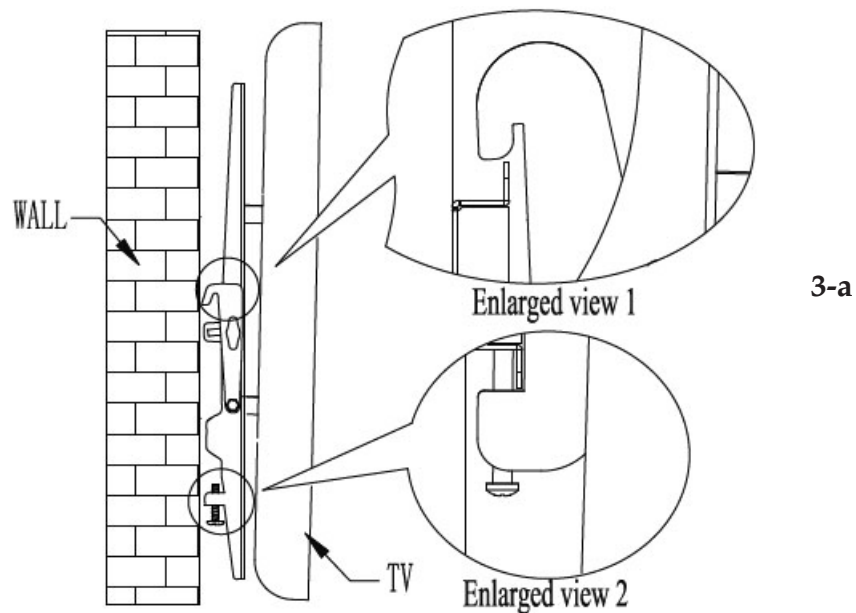

Maintenance

Check the mounting screws every two months for tightness.

Technical Support and Warranty

QUESTIONS? SIIG's **Online Support** has answers! Simply visit our web site at www.siig.com and click **Support**. Our online support database is updated daily with new drivers and solutions. Answers to your questions could be just a few clicks away. You can also submit questions online and a technical support analysts will promptly respond.

SIIG offers a 3-year manufacturer warranty with this product. This warranty covers the original purchaser and guarantees the product to be free of any defects in materials or workmanship for three (3) years from the date of purchase of the product.

SIIG will, at our discretion, repair or replace (with an identical product or product having similar features and functionality) the product if defective in materials or workmanship. This warranty gives you specific legal rights, and you may also have other rights which vary from state to state. Please see our web site for more warranty details.

If you encounter any problems with this product, please follow the procedures below.

- A) If it is within the store's return policy period, please return the product to the store where you purchased it.
B) If your purchase has passed the store's return policy period, please follow these steps to have the product repaired or replaced.

Step 1: Submit your RMA request. Go to www.siig.com, click **Support**, then **Request A Product Replacement** to submit a request to [SIIG RMA](#) or fax a request to 510-657-5962. Your RMA request will be processed, if the product is determined to be defective, an RMA number will be issued.

Step 2: After obtaining an RMA number, ship the product.

- Properly pack the product for shipping. All software, cable(s) and any other accessories that came with the original package must be included.
- Clearly write your RMA number on the top of the returned package. SIIG will refuse to accept any shipping package, and will not be responsible for a product returned without an RMA number posted on the outside of the shipping carton.
- You are responsible for the cost of shipping to SIIG. Ship the product to the following address:

SIIG, Inc.
6078 Stewart Avenue
Fremont, CA 94538-3152, USA
RMA #: _____

- SIIG will ship the repaired or replaced product via Ground in the U.S. and International Economy outside of the U.S. at no cost to the customer.

About SIIG, Inc.

Founded in 1985, SIIG, Inc. is a leading manufacturer of IT connectivity solutions (including Serial ATA and Ultra ATA Controllers, FireWire, USB, and legacy I/O adapters) that bridge the connection between Desktop/Notebook systems and external peripherals. SIIG continues to grow by adding A/V and Digital Signage connectivity solutions to our extensive portfolio. All centered around the distribution and switching of A/V signals over CAT5/6, these products include matrix switches, distribution amplifiers, extenders, converters, splitters, cabling, and more.

SIIG is the premier one-stop source of upgrades and is committed to providing high quality products while keeping economical and competitive prices. High-quality control standards are evident by one of the lowest defective return rates in the industry. Our products offer comprehensive user manuals, user-friendly features, and most products are backed by a lifetime warranty.

SIIG products can be found in many computer retail stores, mail order catalogs, and e-commerce sites in the Americas, as well as through major distributors, system integrators, and VARs.

PRODUCT NAME

Low Profile Universal Tilted TV Mount - 32" to 65"
--

Low Profile Universal Tilted TV Mount - 32" to 65" is a trademark of SIIG, Inc. SIIG and the SIIG logo are registered trademarks of SIIG, Inc. All other names used in this publication are for identification only and may be trademarks of their respective owners.