



HDMI Extender over Dual Cat.X (powered at TX)



P/N: AV-GM02M3-S1



Safety and Notice

The **AV-GM02M3-S1 HDMI Extender over Dual Cat.X (powered at TX)** has been tested for conformance to safety regulations and requirements, and has been certified for international use. However, like all electronic equipments, the **AV-GM02M3-S1** should be used with care. Please read and follow the safety instructions to protect yourself from possible injury and to minimize the risk of damage to the unit.

- Follow all instructions and warnings marked on this unit.
- Do not attempt to service this unit yourself, except where explained in this manual.
- Provide proper ventilation and air circulation and do not use near water.
- Keep objects that might damage the device and assure that the placement of this unit is on a stable surface.
- Use only the power adapter and power cords and connection cables designed for this unit.
- Do not use liquid or aerosol cleaners to clean this unit. Always unplug the power to the device before cleaning.



TABLE OF CONTENTS

INTRODUCTION	1
FEATURES.....	1
PACKAGE CONTENTS	1
SPECIFICATIONS	3
PANEL DESCRIPTIONS	4
Transmitting unit ► TX.....	4
Receiving unit ► RX	4
CONNECTION DIAGRAM	6
HARDWARE INSTALLATION.....	7
HDMI PIN DEFINITION.....	8
CAT5 / RJ45	9
NOTICE	10
WARRANTY	11

INTRODUCTION

The **AV-GM02M3-S1 HDMI Extender over Dual Cat.X (powered at TX)** boosts up the audio/video transmission distance up to 60m in HDTV 1080i format, 40m in HDTV 1080p format, or 20m in HDTV 1080p with 36-bit color depth. With two cost effective solid category cables, users can readily extend HDTV sources from DVD player, Blu-ray Disc player, PS3, PC, and any other kinds of sources compliant with TMDS to distant display monitors including HDMI/DVI enabled TV sets or LCD PC monitors. Therefore any HDMI source device can transmit utmost high quality video and audio over great distance at minimal cost.

The AV-GM02M3-S1 includes two units: transmitting and receiving units. The transmitting unit is used to capture the input HDMI or DVI signals and carry the signals through two RJ45 connectors into two cost effective Cat-5/5e/6 cables. The receiving unit is responsible for equalizing the transmitted HDMI signal. The transmission distance between the sending and receiving units can be up to 60m at HD (720p/1080i) or 40m at Full HD (1080p). With an 8-level equalization rotary control on the receiving unit, users can adjust the equalization strength to the received HDMI signals accordingly, and therefore optimize the transmission distance between source and destination.

FEATURES

- Support HDMI Deep Color & full 3D
- Extends the transmission distance up to 60m (200ft) from the sources under 1080i or 720p
- Extends the transmission distance up to 40m (130ft) from the sources under 1080p
- Provides independent DDC channel, fully HDCP compliant
- Minimizes the cable skew by adjustable 8-level equalization rotary control switch
- Pure unaltered uncompossed HDMI including DTS-HD Master & Dolby TrueHD
- Wall mounting housing design for easy and robust installation
- Perfectly integrated with other HDMI over Cat.X series products



The claimed transmission distance here is subject to the grade of installed cable(s), source device and display.

For over Cat.X/COAX transmission, the cable(s) has to be solid, not stranded. Any keystone jack along the transmission path will kill the transmission performance significantly!

PACKAGE CONTENTS

- 1x AV-GM02M3-S1 [TX and RX]
- 1x DC 5V 4A power supply
- 1x User Manual

SPECIFICATIONS

Model Name	AV-GM02M3-S1	
Technical	AV-GM02M3-S1[Tx]	AV-GM02M3-S1[Rx]
Role of usage	Transmitter [TX]	Receiver [RX]
HDMI compliance	HDMI Deep Color & full 3D	
HDCP compliance	Yes	
Video bandwidth	Single-link 225MHz [6.75Gbps]	
Video support	480i / 480p / 720p / 1080i / 1080p60 up to 36-bit color	
HDMI over UTP transmission [24-bit]	Full HD (1080p)-40m (130ft) [CAT5e] / 50m (165ft) [CAT6] HD (720p/1080i)-50m (165ft) [CAT5e] / 60m (200ft) [CAT6]	
Audio support	Surround sound (up to 7.1ch) or stereo digital audio	
Equalization	8-level digital rotary switch for signal level control at RX	
Input TMDs signal	1.2 Volts [peak-to-peak]	
Input DDC signal	5 Volts [peak-to-peak, TTL]	
ESD protection	[1] Human body model — 19kV [air-gap discharge] & 12kV [contact discharge] [2] Core chipset — 8kV	
PCB stack-up	4-layer board [impedance control — differential 100Ω ; single 50Ω]	
Input	1x HDMI	2x RJ-45
Output	2x RJ-45	1x HDMI
HDMI source control	No	
IR remote control	N/A	
HDMI connector	Type A [19-pin female]	
RJ-45 connector	WE/SS 8P8C with 2 LED indicators	
3.5mm connector	None	None
Rotary control switch	None	8-level signal equalization
Mechanical		
Housing	Metal enclosure	
Dimension s [L x W x H]	Model	[TX/RX] 84 x 61 x 24mm [3.3" x 2.4" x 1"]
	Package	270 x 175 x 80mm [10.6" x 6.9" x 3.1"]
	Carton	450 x 370 x 300mm [1'6" x 1'3" x 11.8"]
Weight	Model	206g [7.3oz] 214g [7.6oz]
	Package	840g [1.9 lbs]
Fixedness	Wall-mounting case with screws	
Power supply	5V 4A DC	
Power consumption	1.5 Watt [max]	
Operation temperature	0~40°C [32~104°F]	
Storage temperature	-20~60°C [-4~140°F]	
Relative humidity	20~90% RH [no condensation]	

PANEL DESCRIPTIONS

Transmitting unit ► AV-GM02M3-S1-TX



1. **HDMI IN:** Connect to a HDMI source device with a HDMI male-male cable.
2. **+5V DC:** Connect to a 5V DC power supply unit.
3. **A/V SIGNAL:** Link a Cat-5/5e/6 cable to the RJ45 **A/V SIGNAL** port on the RX unit of AV-GM02M3-S1.
4. **CTRL CHANNEL:** Link a Cat-5/5e/6 cable to the RJ45 **CTRL CHANNEL** port on the RX unit.

Receiving unit ► AV-GM02M3-S1-RX



5. **Signal Level:** Adjust the 8-level equalization control to the received HDMI signals. The HDMI signal level varies from 0 (strongest) to 7 (weakest) for respective transmission length from longest possible range to short distance. Adjust the signal level from 7 to 0 and stop turning the rotary switch whenever the audio/video is playing normally. Inappropriate signal level setting may cause overpowering issue that would shorten the product life significantly!
6. **HDMI OUT:** Connect to a HDMI display or projector with a HDMI male-male cable.
7. **A/V SIGNAL:** Link a Cat-5/5e/6 cable to the RJ45 **A/V SIGNAL** port on the TX unit of AV-GM02M3-S1.

8. **CTRL CHANNEL:** Link a Cat-5/5e/6 cable to the RJ45 **CTRL CHANNEL** port on the TX unit.

CONNECTION DIAGRAM

- HDMI
- CAT5/5e/6

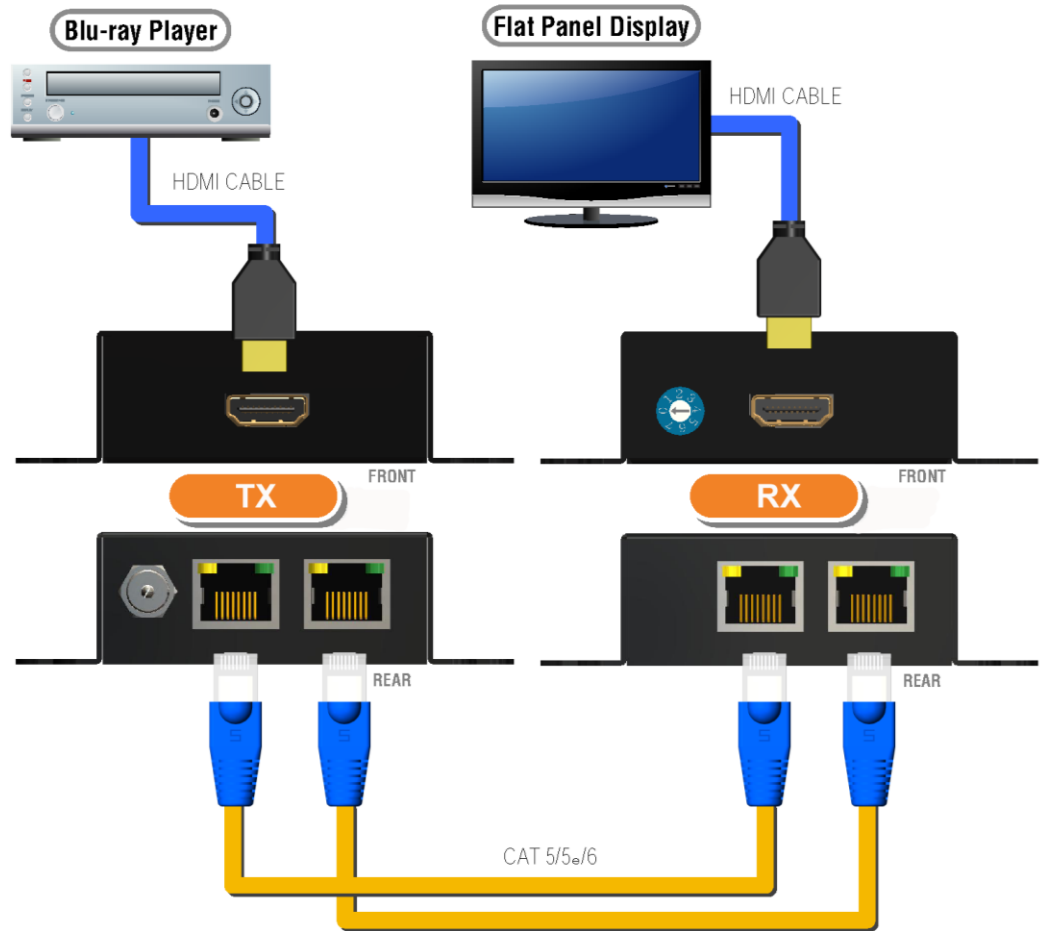

HARDWARE INSTALLATION

1. Connect a HDMI source to the transmitting unit of AV-GM02M3-S1.
2. Connect a HDMI display or projector to the receiving unit of AV-GM02M3-S1.
3. Connect two Cat-5/5e/6 cables between the transmitting and receiving units via **AV SIGNAL** and CTRL CHANNEL RJ45 ports respectively.
4. Make sure these two Cat-5/5e/6 cables are tightly connected and not loose.
5. Plug in the 5V DC power supply unit to the power jack on the transmitting unit of AV-GM02M3-S1.
6. If you see flickering or blinking image on the display, please adjust the rotary control switch to improve the cable skew. 0 stands for the strongest HDMI signal level for longest possible transmission length while 7 stands for the weakest HDMI signal level for short transmission length. Please adjust the EQ signal level from 7 to 0 and stop turning the rotary switch whenever the audio/video is playing normally. Inappropriate signal level setting may cause overpowering issue that would shorten the product life significantly!

HDMI PIN DEFINITION

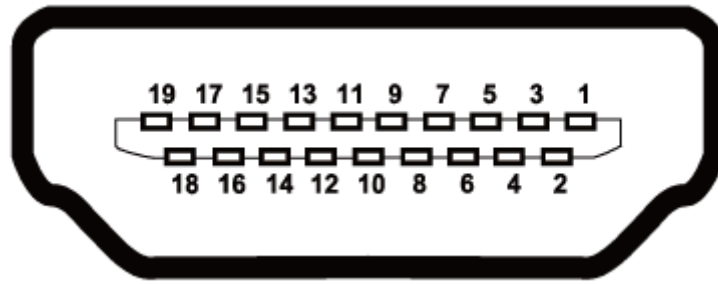









Type A (Receptacle) HDMI

Pin 1	TMDS Data2+	Pin 11	TMDS Clock Shield
Pin 2	TMDS Data2 Shield	Pin 12	TMDS Clock-
Pin 3	TMDS Data2-	Pin 13	NC
Pin 4	TMDS Data1+	Pin 14	Reserved (N.C. on device)
Pin 5	TMDS Data1 Shield	Pin 15	SCL
Pin 6	TMDS Data1-	Pin 16	SDA
Pin 7	TMDS Data0+	Pin 17	DDC/CEC Ground
Pin 8	TMDS Data0 Shield	Pin 18	+5V Power
Pin 9	TMDS Data0-	Pin 19	Hot Plug Detect
Pin 10	TMDS Clock+		







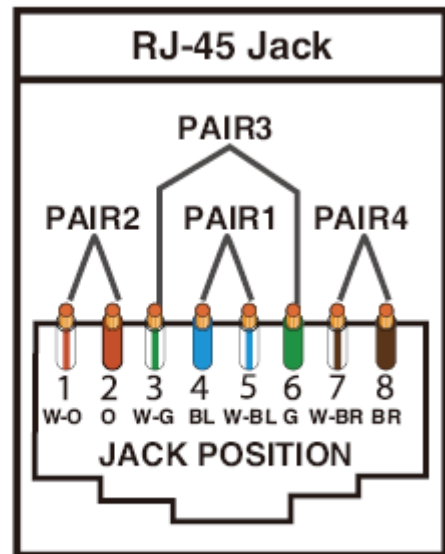

CAT5 / RJ45

Audio/Video Signal port

Data Link TIA/EIA-568-B		
PIN	Color	Function
1	 W-O	TX0-
2	 O	TX0+
3	 W-G	TX1-
4	 BL	TX2-
5	 W-BL	TX2+
6	 G	TX1+
7	 W-BR	TXC-
8	 BR	TXC+



Control Channel port

Data Link TIA/EIA-568-B		
PIN	Color	Function
1	 W-O	Hot Plug Detect
2	 O	CEC
3	 W-G	DDC SCL
4	 BL	DDC SDA
5	 W-BL	GND
6	 G	GND
7	 W-BR	Power
8	 BR	Reserved

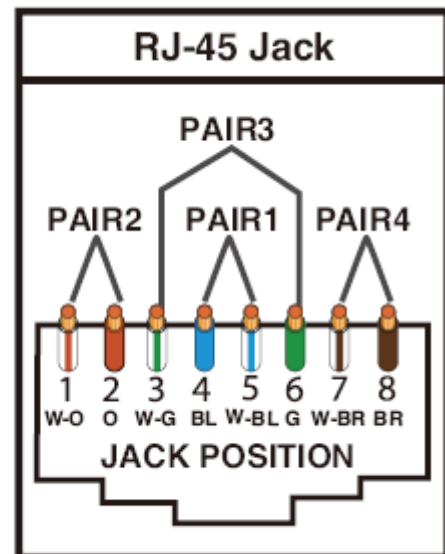

NOTICE

1. When adjusting the signal level on the receiver unit, please dial the rotary control switch from 7 to 0 and stop turning the rotary switch whenever the audio/video is playing normally. Inappropriate signal level setting may cause overpowering issue that would shorten the product life significantly!
2. If the DVI or HDMI device requires the EDID information, please use an EDID Reader/Writer to retrieve and provide DVI or HDMI display EDID information.
3. All HDMI over CAT5 transmission distances are measured using Belden 1583A CAT5e 125MHz UTP cable and ASTRODESIGN Video Signal Generator VG-859C & VG-870B.
4. The transmission length is largely affected by the type of Cat-5/5e/6 cables, the type of HDMI sources, and the type of HDMI display. The testing result shows solid UTP cables (usually in the form of 330m [1,000ft] bulk cables) can transmit a lot longer signals than stranded UTP cables (usually in the form of fixed length patch cords). Shielded STP cables are better suited than unshielded UTP cables. A solid UTP Cat-5e cable shows longer transmission range than stranded STP Cat-6 cable. For long extension applications, solid UTP/STP cables are the only viable choice.
5. EIA/TIA-568-B termination (T568B) for Cat-5/5e/6 cables is recommended.
6. To reduce the interference among the unshielded twisted pairs of wires in Cat-5/5e/6 cable, one can use double shielded STP cables to improve EMI problems, which is worsen in long transmission.
7. Because the quality of the category cables has the major effect on how long the transmission limit can achieve and how good is the received picture quality, the actual transmission range is subject to one's choice of Cat-5/5e/6 cables. For desired resolutions greater than 1080i or 1280x1024, a Cat-6 cable is recommended.
8. If your HDMI display has multiple HDMI inputs, it is found that the first HDMI input [HDMI input 1] generally can produce better transmission performance among all HDMI inputs.



WARRANTY

The SELLER warrants the **AV-GM02M3-S1 HDMI Extender over Dual Cat.X (powered at TX)** free from defects in the material and workmanship for 3 years from the date of purchase from the SELLER or an authorized dealer. Should this product fail to be in good working order within 3 years warranty period, The SELLER, at its option, repair or replace the unit, provided that the unit has not been subjected to accident, disaster, abuse or any unauthorized modifications including static discharge and power surge. This warranty is offered by the SELLER for its BUYER with direct transaction only. This warranty is void if the warranty seal on the metal housing is broken.

Unit that fails under conditions other than those covered will be repaired at the current price of parts and labor in effect at the time of repair. Such repairs are warranted for 90 days from the day of reshipment to the BUYER. If the unit is delivered by mail, customers agree to insure the unit or assume the risk of loss or damage in transit. Under no circumstances will a unit be accepted without a return authorization number.

The warranty is in lieu of all other warranties expressed or implied, including without limitations, any other implied warranty or fitness or merchantability for any particular purpose, all of which are expressly disclaimed.

Proof of sale may be required in order to claim warranty. Customers outside Taiwan are responsible for shipping charges to and from the SELLER. Cables and power adapters are limited to a 30 day warranty and must be free from any markings, scratches, and neatly coiled.

The content of this manual has been carefully checked and is believed to be accurate. However, The SELLER assumes no responsibility for any inaccuracies that may be contained in this manual. The SELLER will NOT be liable for direct, indirect, incidental, special, or consequential damages resulting from any defect or omission in this manual, even if advised of the possibility of such damages. Also, the technical information contained herein regarding the **AV-GM02M3-S1** features and specifications is subject to change without further notice.

Support

For more info or tech support
<http://www.siig.com/support>