

Desk Mount Dual Monitor Arm - Up to 32"

P/N: CE-MT3W11-S1

04-1419A

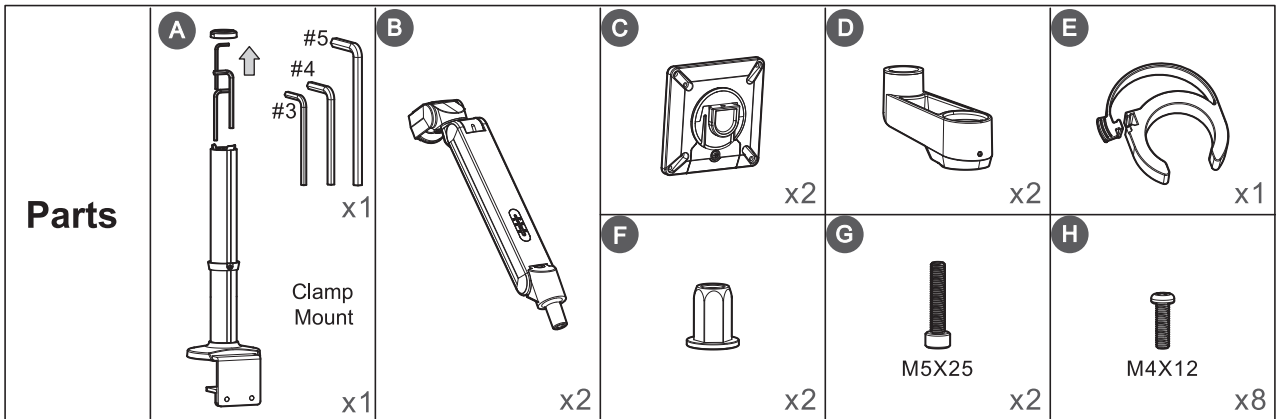
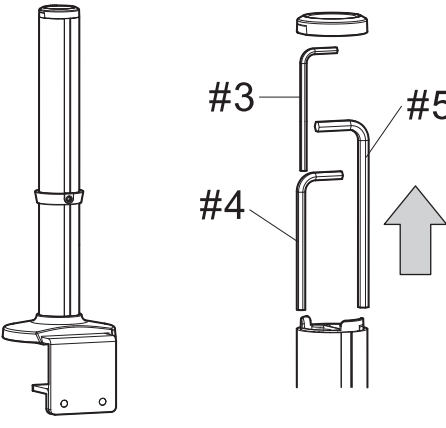
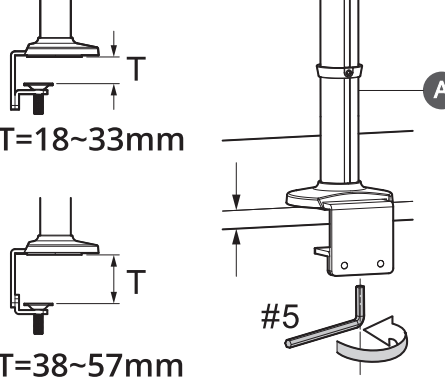
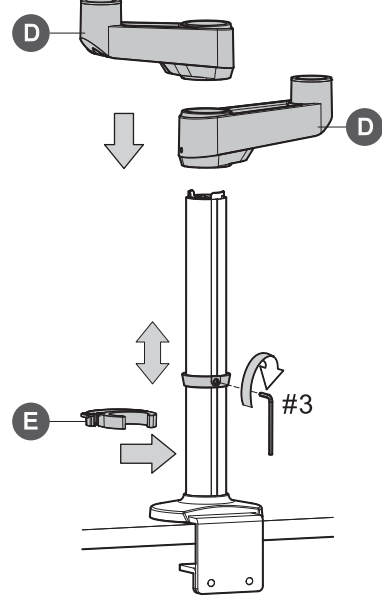
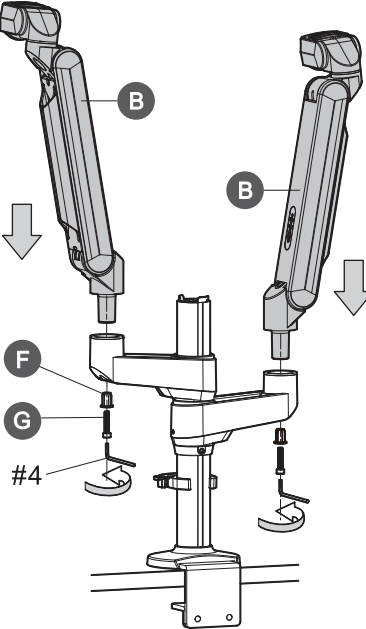
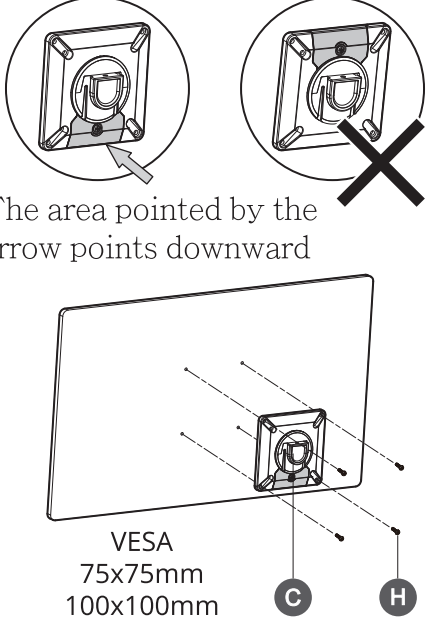
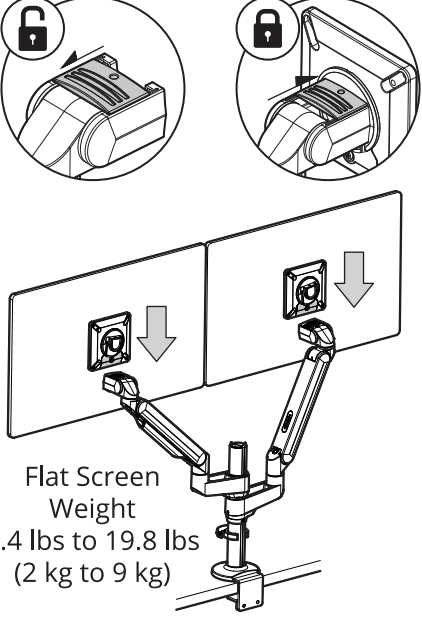

<p>1 Clamp Mount & Tools</p> 	<p>2 Clamp Installation</p> 	<p>3 Pole Arm Installation</p> 
<p>4 Arm Installation</p> 	<p>5 VESA Plate Installation</p>  <p>The area pointed by the arrow points downward</p> <p>VESA 75x75mm 100x100mm</p>	<p>6 Screen Installation</p>  <p>Flat Screen Weight 4.4 lbs to 19.8 lbs (2 kg to 9 kg)</p>

Support

For more info or tech support <http://www.siig.com/support>



1 Cable Management

2

3

Tension Adjustment

#5

Tilt Adjustment

#4

Rotate Adjustment

+

-

Do not totally loosen the screw when the screw at upside to avoid the monitor falling off